



WideTEK® 24F



Setup Instructions English

03/2023

Table of Contents

Revision overview	4
Notes on the instructions and the manufacturer	4
Keep instructions available	4
Design features in the text	5
Design features in illustrations.....	6
Associated documents	6
Copyright	7
Contact details of the manufacturer in Germany	7
Technical support	7
Contact details of the manufacturer in the USA	7
Device safety	8
Intended use.....	8
Basic safety instructions.....	9
Responsibility of the operator.....	10
Personnel qualification.....	10
Design features of warnings.....	11
Design features of notices of damage to property	11
Description	12
Task and function	12
Overview WideTEK® 24F	13
Overview back side.....	14
Overview screen for the setup menu	15
Rating plate	16
Serial number	16
User interfaces	17
Installation site	18
Environmental conditions	18

Prepare setup	19
Connecting the power adapter	19
Establish network connection	20
Connecting the foot switch	20
Connecting the optional monitor.....	21
Connecting the optional touch screen	21
Switch on scanner	22
Switch off scanner	24
Perform setup	26
Setup Wizard	26
Perform calibrations	28
Activate setup menu	28
System Restore	31
Solid State Disk Software Error	31
Recovery points.....	31
System Restore to Factory Defaults	32
System recovery of user settings	33
Cleaning	34
Technical Specifications	35
Optical System	35
Electrical Specifications	36
Dimensions and Weight	37
Ambient Conditions	37
More Flatbed Scanner WideTEK® 24F Documentation	38

Revision overview

Date	Rev.	Name	Description of change	Reason for change
02.06.2021	1.0	JKN	First draft	First published version
02.03.2023	1.1	JKN	Second draft	Updated version

Notes on the instructions and the manufacturer

This manual will help you to safely prepare and perform the setup for the WideTEK® 24F flatbed scanner. The WideTEK® 24F flatbed scanner is hereinafter referred to as the "scanner".

The start button is referred to as the "power button" in this manual.

Keep instructions available

This manual is part of the scanner.

- Always keep this manual with the scanner.
- Make sure the manual is available to the user.
- Include this manual when selling or otherwise transferring the scanner.

Design features in the text

Various elements of this guide have specified design features. This allows you to easily distinguish the following elements:

normal text

BUTTONS OF THE SCREEN

"menu labels"

➤ Action steps

- first level enumeration

Cross-references

 Tips contain additional information, such as specific details on how to prepare and perform the setup.

Design features in illustrations

When elements are referred to in a legend or in the running text, they are given a number (1).

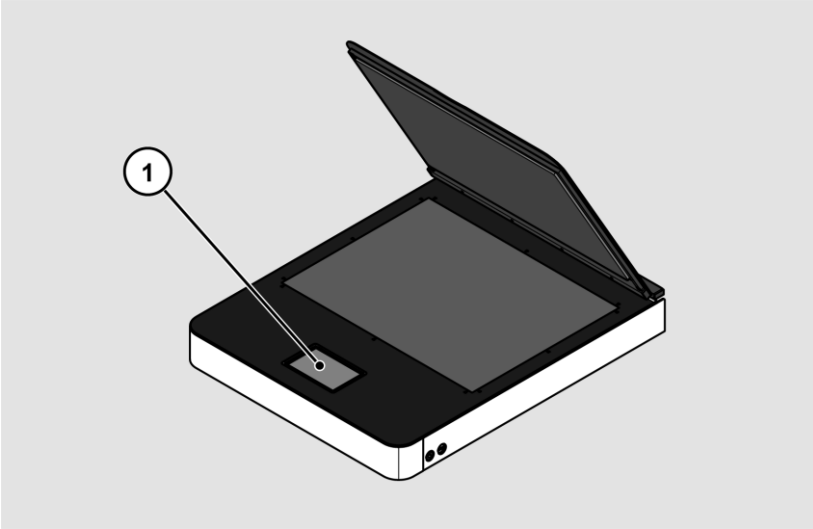

Associated documents

Accompanying documents include:

- Unpacking and packing instructions
- Legal information (EC declaration of conformity, safety and EMC certificates, RoHS etc.).

Copyright

This manual contains information that is subject to copyright. This manual may not be copied, printed, filmed, processed, reproduced or distributed in any form, in whole or in part, without the prior written permission of Image Access GmbH.

© Image Access GmbH 2023

All rights reserved.

Trademark

Scan2Net®, Scan2Pad®, Bookeye® and WideTEK® are registered trademarks of Image Access, all other trademarks belong to their respective owners.

Contact details of the manufacturer in Germany

Image Access GmbH
Hatzfelderstraße 161-163
42281 Wuppertal
Tel.: +49-202-27058-0
E-Mail: dokumentation@imageaccess.de
Internet address: www.imageaccess.de

Technical support

You can reach Image Access GmbH technical support at the following e-mail address: support@imageaccess.de.

Contact details of the manufacturer in the USA

Image Access LP
400 N. Belvedere Drive
Gallatin, TN 37066 USA
Tel: +1-224-293-2585
Email: support@imageaccess.us
Web address: www.imageaccess.us

Device safety

Intended use

The scanner is used for scanning all kinds of images and documents. The documents must comply with the characteristics according to the technical specifications. The scanner is intended for use in closed rooms in the commercial sector.

Intended use also includes reading and understanding this manual and observing and following all instructions in this manual, especially the safety instructions. Any other use is expressly considered improper and will void any warranty and liability claims.

Environmental conditions

Make sure that the scanner is used only under the following environmental conditions:

- Ambient temperature during operation: 5 °C to 40 °C (41 °F - 104 °F)
- Storage temperature: 0 °C to 60 °C (32 °F to 140 °F)
- Relative humidity: 20 to 80 %, non-condensing

➤ Ensure that the scanner is not exposed to direct sunlight.

Basic safety instructions

Avoid injury or death from electric shock

- Never open the scanner case.
- Do not expose the scanner to dripping or splashing water, and do not place containers filled with liquid on the scanner. Liquid ingress may damage the scanner.
- Do not insert any objects into the scanner through any slots or openings.
- Only connect the scanner to a properly installed and grounded power outlet using the supplied power adapter.
- Do not use the power adapter if the housing or the cable of the power adapter is damaged. In this case, replace the power adapter with a one of the same type.
- Do not use the scanner if it is visibly damaged. In this case, unplug the power cord from the wall outlet. Contact Image Access technical support, see the *Technical Support* section beginning on page 7.

Avoid burns

- Do not cover the existing openings in the scanner housing. They are used for ventilation. Otherwise, the scanner could overheat.
- Do not place the scanner in front of air conditioners that emit intense heat.

Avoid cuts

The glass plate of the scanner is only suitable for the weight of documents. Objects or body parts with higher weight may destroy the glass plate and cause cuts.

- Make sure that the weight of the item to be scanned does not exceed 10 kg (22 lbs.)

Avoid broken bones, bruises and contusions

Incorrect routing of the cables can cause tripping.

- Lay the connection cables so that no one can trip over them.

Device safety

The scanner weighs 28 kg (62lbs.).

- Handle the scanner only with the help of a second person.
- Place the scanner only on a solid, level, vibration-free surface that is strong enough to support the weight of the scanner.

Avoid material damage or malfunctions

- Ensure good room ventilation to maintain ambient conditions.
- Do not place the scanner near equipment that emits strong electromagnetic radiation.
- Always place the scanner on a suitable, stable table.
- Do not use cleaning agents containing abrasive additives, solvents or acids. Use a damp microfiber cloth.
- Only operate the touchscreen with your finger or a suitable, conductive pen with a rubber tip. Other objects can damage the touchscreen.

Responsibility of the operator

The scanner operator must ensure that only qualified personnel perform the scanner setup.

Personnel qualification

Personnel performing setup of the scanner must be knowledgeable in setting up, connecting, and operating computer accessories.



Design features of warnings

This manual contains the following warnings:

 WARNING	
	Notes with the word WARNING warn of a dangerous situation that can possibly lead to death or serious injury.

 CAUTION	
	Notes with the word CAUTION warn of a situation that may result in minor or moderate injury.

The following symbols are used in the warnings:

Symbol	Explanation
	Danger due to electric shock
	General danger symbol

Design features of notices of damage to property

CAUTION!	
	Notes with the word CAUTION warn of a situation that will result in property damage.

Description

Task and function

The scanner is used for scanning all kinds of images and documents. The characteristics of the documents such as size, weight must comply with the specifications found in the technical data. The scanner is intended for use in closed rooms in the commercial sector.

Intended use also includes observing and following all information in this manual, especially the safety instructions. Any other use is considered improper and will void the warranty and liability claims.

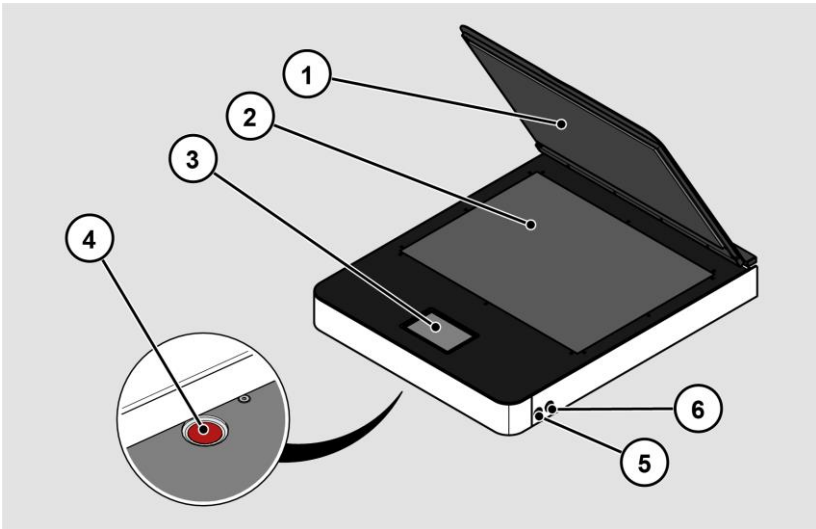
Overview WideTEK® 24F

No.	Designation
1	Removable and height adjustable lid
2	Glass plate
3	Touchscreen
4	Reset button
5	Power button
6	USB connection socket

Description

Overview back side

The following figure shows the back of the scanner.

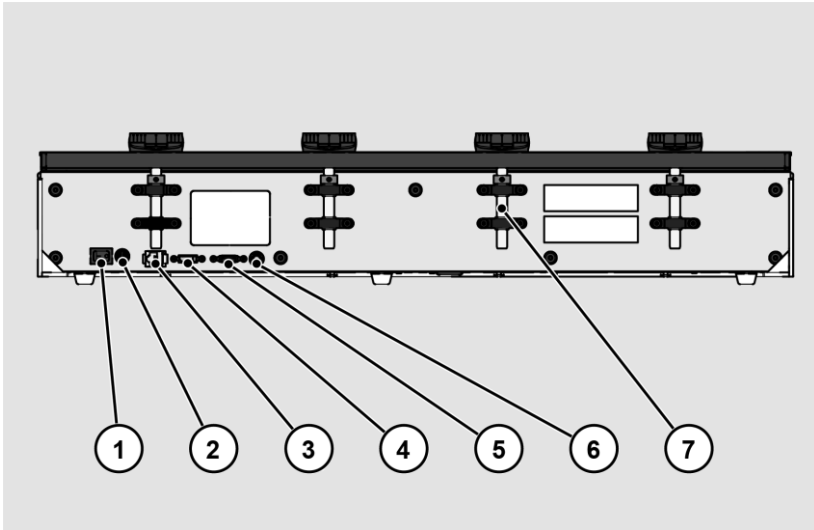

No.	Designation
1	Main power switch
2	Connection socket 24 V DC for external power adapter
3	Network connection socket
4	DisplayPort connector socket
5	USB connection socket
6	Connection socket for foot switch
7	Four cylinder bolts with shaft collars for height adjustment

Overview screen for the setup menu

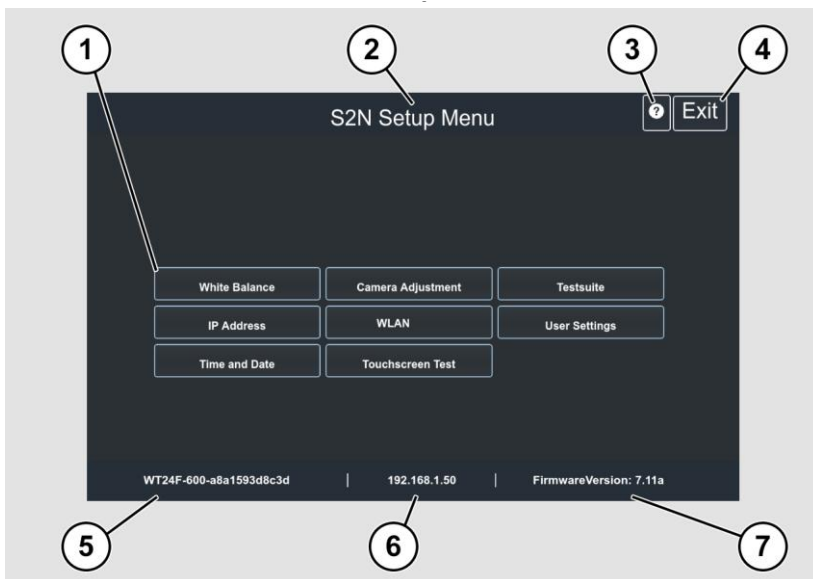

No.	Designation
1	Buttons and parameters
2	Display of the menu designation
3	Display of online help ¹
4	Button for exiting the setup menu to the start screen
5	Display of the serial number
6	Display of the IP address
7	Display of the firmware version

¹ Online Help display is only available when a second touch screen is connected to the scanner.

Description

Rating plate

The rating plate is located on the back of the scanner.

The following figure shows the rating plate of the WideTEK®24F model.



Serial number

The serial number of the scanner is located on the back of the device.

Keep the serial number handy when calling for support.

User interfaces

The scanner can be operated in five ways.

- Via the touch screen and the ScanWizard Touch user interface.
- Via EasyScan or a client application.
- Via a standard web browser and the ScanWizard Client interface.
- Via the optional Scan2Pad® Hotspot.
- Via external scanning applications.

Installation site

Environmental conditions

When operating the scanner, make sure that the room is well ventilated to ensure the proper operating conditions.

The installation site must be chosen so that

- The side distance between scanner and wall is at least 100 mm,
- The distance between the back of the scanner and the wall is at least 50 mm,
- The distance to a door or room entrance is at least one meter.

Place the scanner on a level and stable base. The load-bearing capacity of the base must be suitable for the weight of the scanner (maximum 30 kg, 66 lbs.). The dimensions of the base must be suitable for the footprint of the scanner.



- ⓘ After changing from a cold to a warm environment, allow at least one hour for the scanner to adjust to the ambient temperature before turning it on.



When the scanner changes from a cold to a warm environment, condensation moisture may form inside the housing.

This disappears when the housing temperature has adjusted to the ambient temperature. Condensation moisture can lead to poor scanning results or even damage the scanner.

Prepare setup

Connecting the power adapter



 WARNING	
	<p>Risk of electric shock due to incorrect connection.</p> <ul style="list-style-type: none"> ➤ Ensure that the mains socket is earthed in accordance with local regulations.

 CAUTION	
	<p>Incorrect routing of the connection cables can cause tripping, broken bones, bruises and crushing.</p> <ul style="list-style-type: none"> ➤ Lay the connection cables so that no one can trip over them.

To connect the power supply, proceed as follows:

- Make sure the scanner's main power switch is turned off (0 position).
- Use only the supplied power adapter and power adapter cable.
- Make sure that the power adapter cable is undamaged.
- Connect the low voltage plug to the corresponding DC connector on the back of the scanner.
- Connect the power adapter plug to a power outlet of suitable voltage. (100-240 V AC)



Establish network connection

 CAUTION	
	<p>Incorrect routing of the connection cables can cause tripping, broken bones, bruises and crushing.</p> <ul style="list-style-type: none">➤ Lay the connection cables so that no one can trip over them.

To establish the network connection, follow the steps below:



- Connect one plug of the supplied network cable to the network connection jack on the back of the scanner.
- Connect the second plug to the network connection socket of an existing network.

Connecting the foot switch

 CAUTION	
	<p>Incorrect routing of the connection cables can cause tripping, broken bones, bruises and crushing.</p> <ul style="list-style-type: none">➤ Lay the connection cables so that no one can trip over them.

- Connect the foot switch plug to the foot switch connector on the back of the scanner.



Connecting the optional monitor

 CAUTION	
	<p>Incorrect routing of the connection cables can cause tripping, broken bones, bruises and crushing.</p> <ul style="list-style-type: none"> ➤ Lay the connection cables so that no one can trip over them.

To connect an optional monitor, follow the steps below:

- Connect the DisplayPort connector of the monitor to the DisplayPort connector on the back of the scanner.

Connecting the optional touch screen

 CAUTION	
	<p>Incorrect routing of the connection cables can cause tripping, broken bones, bruises and crushing.</p> <ul style="list-style-type: none"> ➤ Lay the connection cables so that no one can trip over them.

To connect an optional touch screen, follow these steps:

- Connect the DisplayPort connector of the touchscreen to the DisplayPort connector jack on the back of the scanner.
- Connect the USB connector of the touchscreen to the USB connector on the back of the scanner.

Switch on scanner

To switch on the scanner, proceed as follows:

- Press the MAIN POWER SWITCH (1) to the "I" position.

The following figure shows the WideTEK® 24F model.

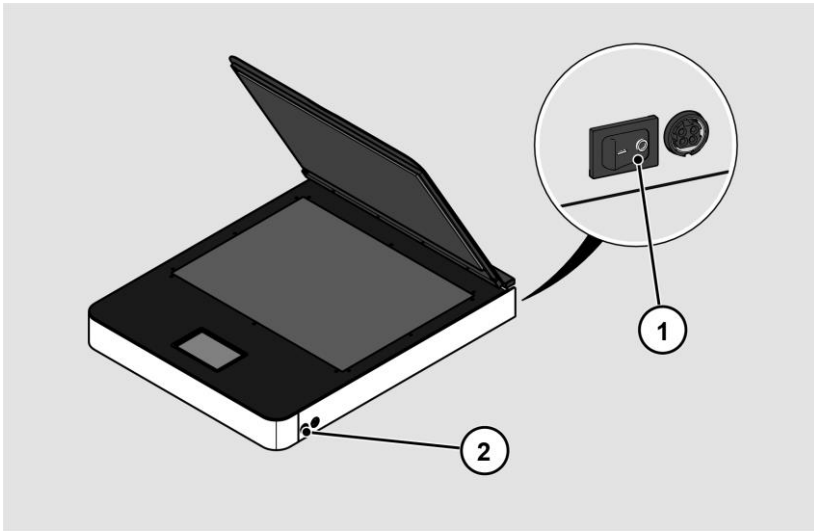

The scanner is in stand-by mode.

To exit stand-by mode, proceed as follows:

- Press the power button (2).

The power button lights up blue.

The scanner performs a system test. After a short waiting time, the "Startup Screen" screen is displayed in English.

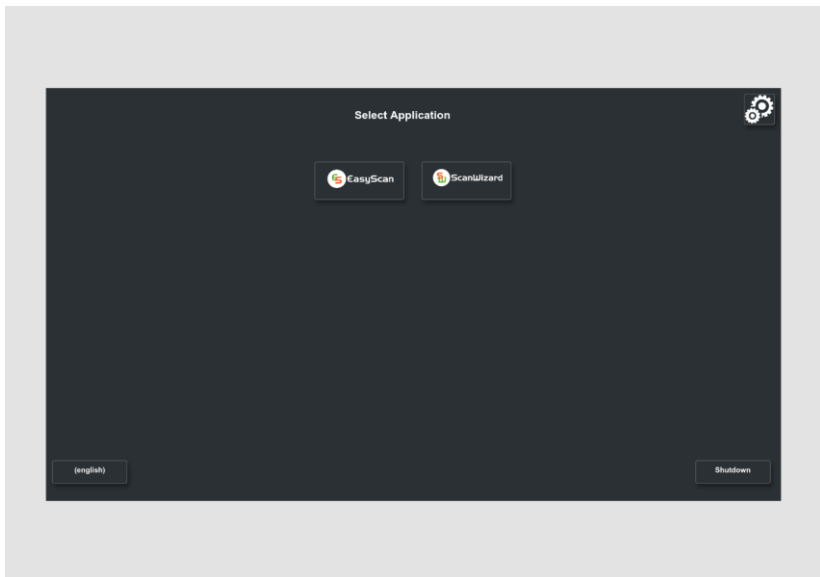

Switch off scanner

To switch the scanner to stand-by mode after performing the setup, proceed as follows:

- On the Select Application screen, tap SHUTDOWN (1).

You can also press the POWER button briefly to access this menu. Do not press the POWER button for longer than 5 seconds, otherwise the scanner will be forced off.

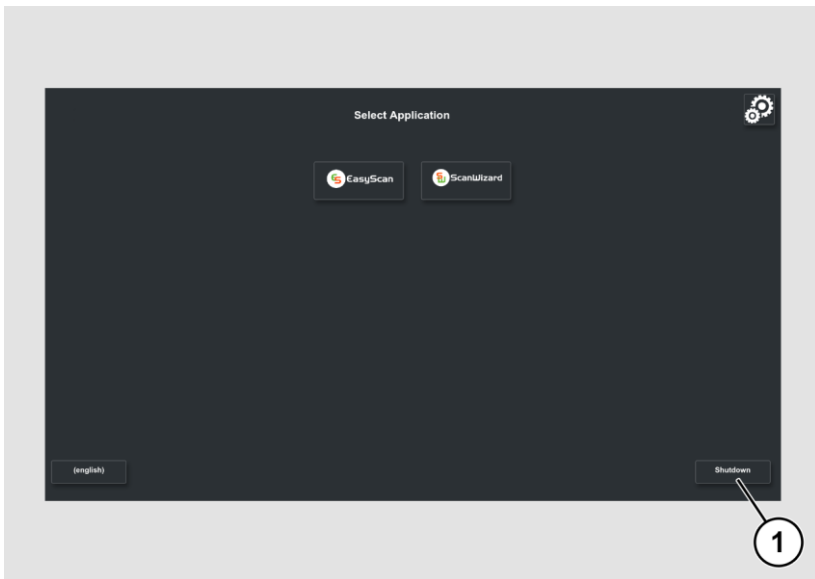

- Confirm with YES.

The scanner will shut down. This process can take up to approx. 40 seconds.

The scanner is in stand-by mode.

If you will not be using the scanner for an extended period of time, you can further reduce power consumption by turning off the stand-by power. To do this, follow the steps below:

- Make sure the scanner is in stand-by mode.
- Press the MAIN POWER SWITCH (1) to the "0" position.

The following figure shows the WideTEK®24F model.

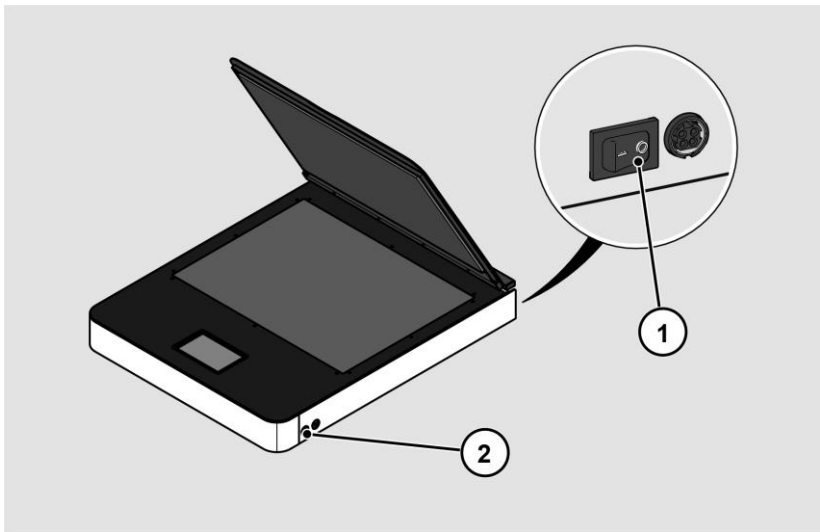

Perform setup

Setup Wizard

The Setup Wizard is displayed on the touchscreen immediately after the startup process is complete.

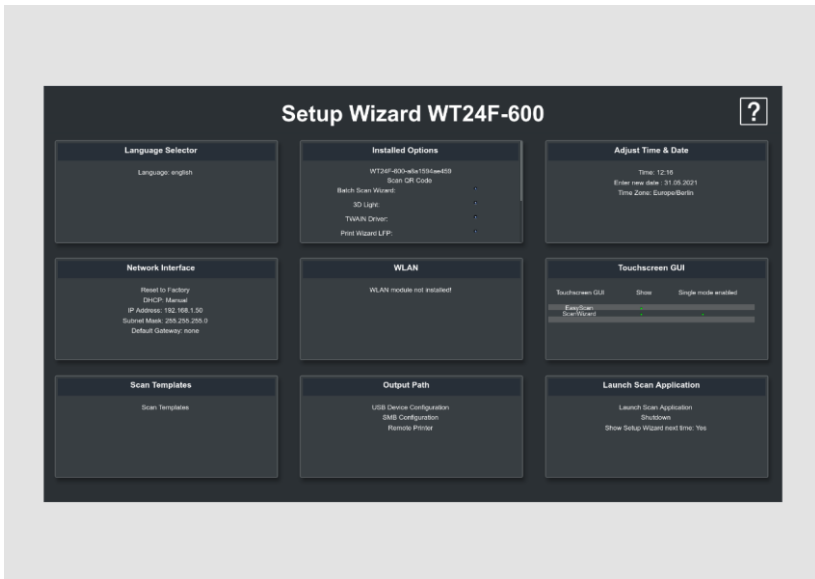

The Setup Wizard allows the user to perform the most important settings on the touch screen during the initial installation of a Scan2Net scanner. After the Setup Wizard has been successfully completed, the scanner can be used immediately without any further settings.

All user interfaces of the Setup Wizard are described in the online help.

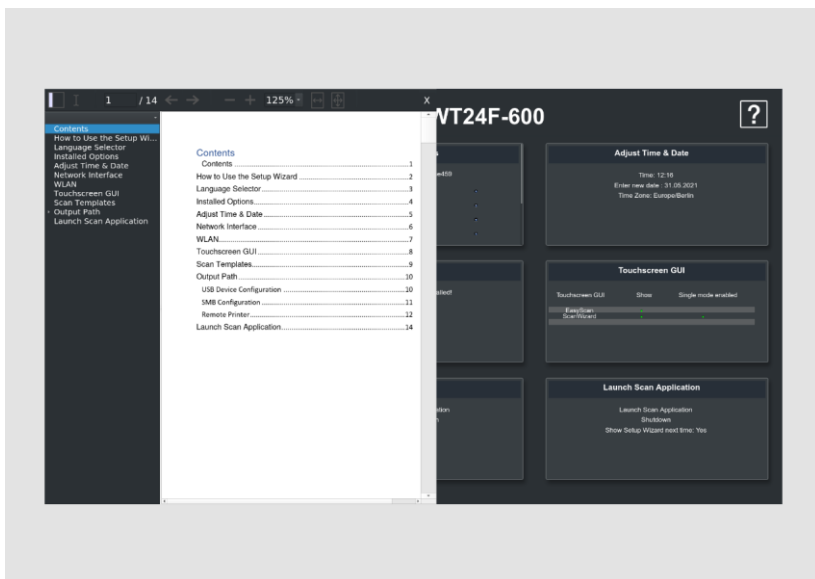

To exit the Setup Wizard you have to deactivate it in the LAUNCH SCAN APPLICATION tile.

Starting the Setup Wizard after booting the scanner can be reactivated in the DEVICE SETUP section of Scan2net.

- Open a tab in a web browser and enter the IP address assigned to the scanner in the address bar.
- The Scan2Net window will appear.
- Click the SETUP DEVICE button, and then click the POWERUSER button.
- Enter "Poweruser" as the login name and password.
- Select the SETUP WIZARD button from the Administrative Settings menu.
- Finally, select YES in the Setup Wizard menu.

Perform calibrations

Activate setup menu

To activate the setup menu, you must log in. To do this, proceed as follows:

- Tap on the GEAR SYMBOL (1).

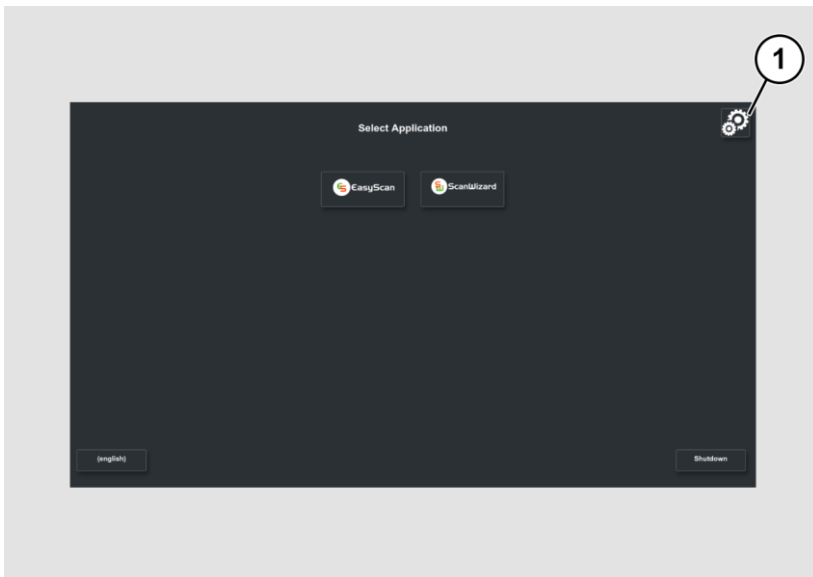

The login screen is displayed.

- Enter the login data in the login window.
- To do so, tap the corresponding input field with your finger.
- The on-screen keyboard is displayed.
- Enter "Poweruser" in both input fields.
- Note that the input is case sensitive.

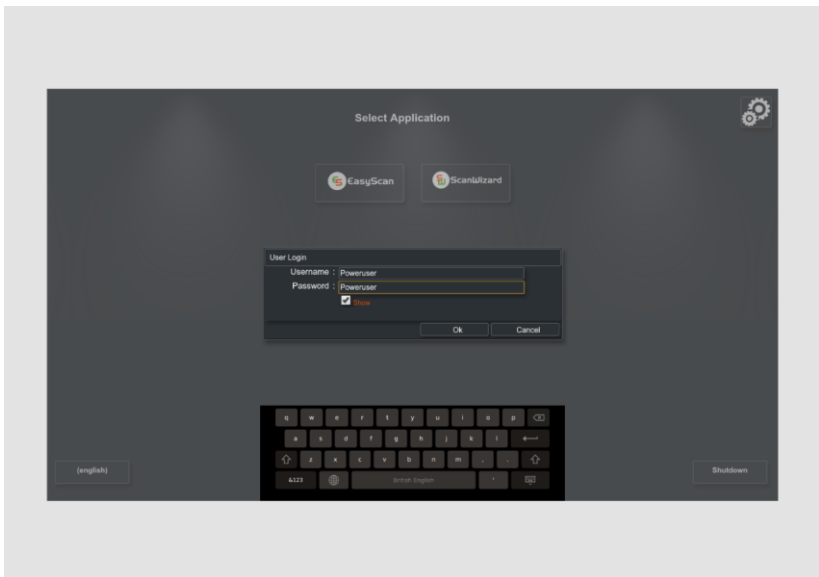

- To complete the registration, tap OK.

The S2N Setup Menu screen appears.

Overview screen page for the setup menu



- White balance: Display the "White Balance" submenu.
- Camera Adjustment: Display the "Camera Adjustment" submenu.
- Test Suite: Display the "Test Suite" submenu.
- IP Address: Display the "IP Address" submenu.
- Wireless Network: Display the "WLAN" submenu.
- User Settings: Display the "User Settings" submenu.
- Time and Date: Display the "Time and Date" submenu.
- Touchscreen Test: Display the "Touchscreen test" submenu.

- To select a submenu on the S2N Setup Menu screen page, tap the corresponding button on the screen page with your finger.
- All user interfaces of the setup menu are described in the online help.

System Restore

Solid State Disk Software Error

The file system and Linux operating system of a Scan2Net scanner are very robust and fault tolerant. The file system is capable of repairing itself even if the system loses power during a hard drive write, which would almost certainly damage any Windows, Android, or MAC operating system based computer. However, it is still possible for the Scan2Net Linux software on the SSD to become corrupted under certain circumstances. Unexpected power outages, hard shutdowns via the main power switch without a prior controlled shutdown, and other unexpected interruptions to the operating system can cause this type of disruption. In addition, any uncontrolled interruption of a firmware update procedure or other functions that involve writing to main storage (SSD) poses a potential risk to the integrity of the firmware on the SSD. The Scan2Net operating system of any WideTEK® or Bookeye® scanner is Linux based and although it is very rare, Linux can be corrupted like any other operating system.

If the Linux operating system or other parts of the SSD are damaged, there is still no need to replace the SSD, at least not until the recovery procedure is performed once. These recovery procedures are similar to the procedures necessary to restore other operating systems to a previous state.

Recovery points

Up to two backup copies of the Scan2Net Linux operating system are stored on the internal SSD. The first copy is created during manufacturing. This is the restore point labeled "Factory Default". The second can be created by the user at any time. This is the restore point labeled "User Settings".

System Restore to Factory Defaults

The recovery procedure is a simple process:

Step	Action
1	Turn off the scanner either from the touchscreen, from the Scan2Net application currently in use, or by pressing the POWER button. If the device does not go into standby mode, press and hold the POWER button for more than 5 seconds to hard-switch the scanner into standby mode. If the device does not hard-switch into stand-by mode, press the MAIN POWER SWITCH to the "0" position to turn off the scanner.

- i** Make sure that the following process is not interrupted by a hard shutdown or power failure.
If this process is interrupted, loss of the system restore point is possible, so the SSD must be physically replaced.

- i** The following process cannot be influenced by the user.

Step	Action
2	Make sure the main power is on and the scanner is in standby mode.
3	Press and hold the red RESET button at the front, on the bottom plate of the scanner, before turning it on! Turn on the scanner by pressing the POWER button. Note: During the power-up process, the RESET button must be pressed and held until it lights up continuously!
4	Restoration of the file system will begin immediately. This process takes about 1 - 2 minutes. At the end of the recovery process, the scanner will automatically reboot.

System recovery of user settings

Set system restore point

Step	Action
1	Open a tab in a web browser and enter the IP address of the scanner.
2	The Scan2Net window appears.
3	Click SETUP DEVICE, and then click POWERUSER.
4	Enter "Poweruser" as the user name and password.
5	Select SYSTEM RESTORE from the RESETS AND DEFAULT VALUES menu.
6	Select SET RESTORE POINT.

Please wait until the process is complete and the READY message is displayed. The entire process takes about 1 - 2 minutes.

System Restore

Step	Action
1	Open a tab in a web browser and enter the IP address of the scanner.
2	The Scan2Net window appears.
3	Click SETUP DEVICE, and then click POWERUSER.
4	Enter "Poweruser" as the username and password.
5	Select SYSTEM RESTORE from the RESET & DEFAULT VALUES menu.
6	Select RESTORE SYSTEM.

The unit restarts immediately. The system recovery is then performed. This procedure takes approximately 1 - 2 minutes. To complete the procedure, the device performs a second restart of the restored system.

End of the system recovery procedure.

Cleaning

To keep the scanner in good working condition, make sure it is free of dust, ink, grease, and other contaminants. Scanners are high resolution optical instruments with high quality glass parts. Since a higher quality scanner will reveal smaller particles of dirt and dust better than a lower quality scanner, special care must be taken to keep all parts, and especially all glass parts, as clean as possible.

The cleaning intervals are determined by the scanner environment and the type of documents scanned, as well as the frequency of use. The scanner should be cleaned under the following circumstances.

- When sporadic or frequent image quality problems occur.
- When sporadic or frequent cropping problems occur, even though the document is in the correct area of the scan area.

 To avoid electric shock and other potential damage, make sure the scanner is turned off and unplugged before cleaning. Do not allow water to enter the scanner.

Proper general cleaning should include the following:

- Use an electric vacuum cleaner to remove dust from all parts before proceeding to clean other parts of the product. Be careful not to touch any parts with the dust cleaning hose.
- Clean the outer surface of the Product with a damp cloth. Dampen the cloth and wring it out as much as possible. For best results, use a microfiber cloth.
- The glass surfaces of the scanner should only be cleaned using a soft, lint-free cloth.
- Use a mild soap and water solution only when necessary. Do not use abrasive cleaners.
- Wipe the product dry with a soft, lint-free cloth. Be especially careful when cleaning the touch screen.

Technical Specifications

Optical System

Maximum Document Size	610 x 457 mm (24 x 18 inch)
Scanner Resolution	1200 × 1200 dpi
Optical Resolution	1200 × 600 dpi
Pixel Dimension	9.3 × 9.3 μm
Sensortype	CIS line sensor with long focal length selfoc lens, depth of field +- 1mm @600dpi
Color Depth	48 bit color (internal resolution) 16 bit grayscale (internal resolution)
Scan Modes	24 bit color, 8 bit greyscale, bitonal, halftone
File Formats	Multipage PDF (PDF/A) and TIFF, JPEG, JPEG 2000, PNM, PNG, BMP, TIFF (Raw, G3, G4, LZW, JPEG), AutoCAD DWF, JBIG, DjVu, DICOM, PCX, Postscript, EPS, Raw data and more

Electrical Specifications

External Power Supply

Voltage	100 - 240 V AC
Frequency	47- 63 Hz
Operating Temperature	5 to 40 °C (40 to 105 °F)
Relative Humidity	20 to 80 % (non-condensing)
ECO Standard	CEC Level VI

Scanner

Voltage	24 V DC
Current	Max. 5 A

Illumination System

Light Source	RGB LEDs, with integrated diffusor tested according to IEC 62471, no IR/UV emission
Warm-up Time	None
Temperature Dependency	None
UV / IR Emission	None
Lamp Lifetime	50,000 hours typical. Lamps are covered by the Extended Warranty Option

Power Consumption

Sleep	< 0.5 W
Stand-by	2.5 W
Ready to Scan	35 W
Scanning	70 W

Dimensions and Weight

Scanner Outer Dimensions (H × W × D)	140 x 730 x 900 mm (5.5 x 29 x 36 inch)
Weight Scanner	28 kg (62 lbs.)
Dimension Transport Box (H × W × D)	250 x 800 x 1000 mm (10 x 31.5 x 40 inch)
Scanner Weight, Ready to Ship	33 kg (73 lbs.)

Ambient Conditions

Operating Temperature	5 to 40° C (40 to 105 ° F)
Storage Temperature	0 to 60° C (32 to 140 °° F)
Relative Humidity	20 to 80% (non-condensing)
Noise	< 42 dB(A) (Operating) < 25 dB(A) (Stand-by)

End of the document

More Flatbed Scanner WideTEK® 24F Documentation

To get the best possible results from your WideTEK® 24F flatbed scanner and to fully understand its operation, you should always have the latest version of the manuals, instructions, and other product documentation. The printed version may already be out of date. You can use the respective QR code or hyperlink shown here to check whether your product documentation is complete and up to date. The documents are available in English, German, Spanish and French.

<https://www.imageaccess.de/?page=ScannersWT24F-600Documentation&lang=en>

